

TAE-5450

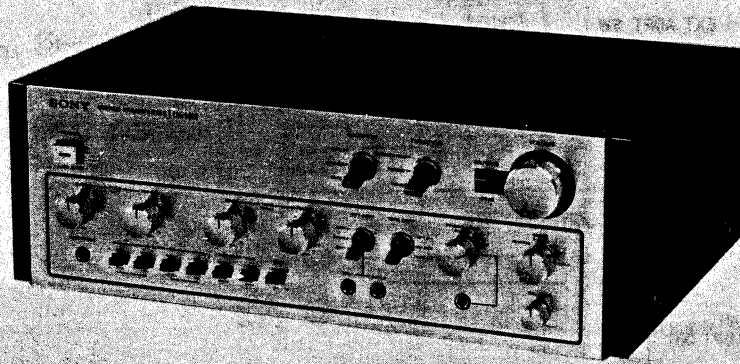

STEREO PREAMPLIFIER

SPECIFICATIONS

Inputs:

	Sensitivity	Impedance	Maximum input capability (THD 0.1%)	S/N (weighting network, input level)
PHONO 1, 2	1.5 mV	50 k Ω	140 mV	70 dB (A, 1.5 mV)
TUNER AUX 1-3 TAPE 1, 2 EXT ADPT 1, 2	150 mV	50 k Ω	—	90 dB (A, 1.5 mV)

Outputs:

	Voltage	Impedance
REC OUT 1, 2	150 mV (max. 12 V)	1 k Ω
EXT ADPT 1, 2	150 mV (max. 12 V)	1 k Ω
HEADPHONE	0.3 V (8 Ω headphones) 3 V (10 k Ω headphones)	50 Ω
OUTPUT 1 2	1 V (max. 14 V)	1 k Ω 2 k Ω

Voltage amplification: (at 1 kHz)

Input	Output			
	REC OUT 1, 2	EXT ADPT 1, 2	HEADPHONE	OUTPUT 1, 2
PHONO 1, 2	40 dB	40 dB	48 dB	58 dB
TUNER AUX 1-3 TAPE 1, 2 EXT ADPT 1, 2	0 dB	0 dB	8 dB	18 dB

Harmonic distortion: Less than 0.03% at rated output

Intermodulation (IM) distortion: Less than 0.05% at rated output
(60 Hz: 7 kHz = 4:1)

Frequency response: PHONO 1, 2 RIAA equalization curve ± 0.4 dB
TUNER
AUX 1-3
TAPE 1, 2
EXT ADPT 1, 2 } 10 Hz-100 kHz $^{+0}_{-1}$ dB

Tone controls: BASS
 ± 10 dB at 50 Hz (TURNOVER 250 Hz)

± 10 dB at 100 Hz (TURNOVER 500 Hz)
TREBLE
 ± 10 dB at 10 kHz (TURNOVER 2.5 kHz)
 ± 10 dB at 20 kHz (TURNOVER 5 kHz)

Filters: LOW
12 dB/octave attenuation below 10 Hz or 40 Hz
HIGH
12 dB/octave attenuation above 9 kHz or 20 kHz

Residual noise: Less than 200 μ V, 70 μ V (at frequencies below 20 Hz)
(with VOLUME set to minimum, TONE canceled, FILTERS off)

GENERAL

Power requirements: 110, 127, 220 or 240 V ac adjustable, 50/60 Hz
100, 120, 220 or 240 V ac adjustable, 50/60 Hz

Power consumption: 9 watts

AC outlets: 2 switched 300 watts, 1 unswitched 200 watts

Dimensions: Approx. 460(w) x 168(h) x 323(d) mm
18 $\frac{1}{8}$ (w) x 6 $\frac{5}{8}$ (h) x 12 $\frac{3}{4}$ (d) inches
Including projecting parts and controls

Weight: Approx. 9.2 kg (20 lb 5 oz) in net
11.6 kg (25 lb 9 oz) with shipping carton

SONY®

SERVICE MANUAL

1. BLOCK DIAGRAM

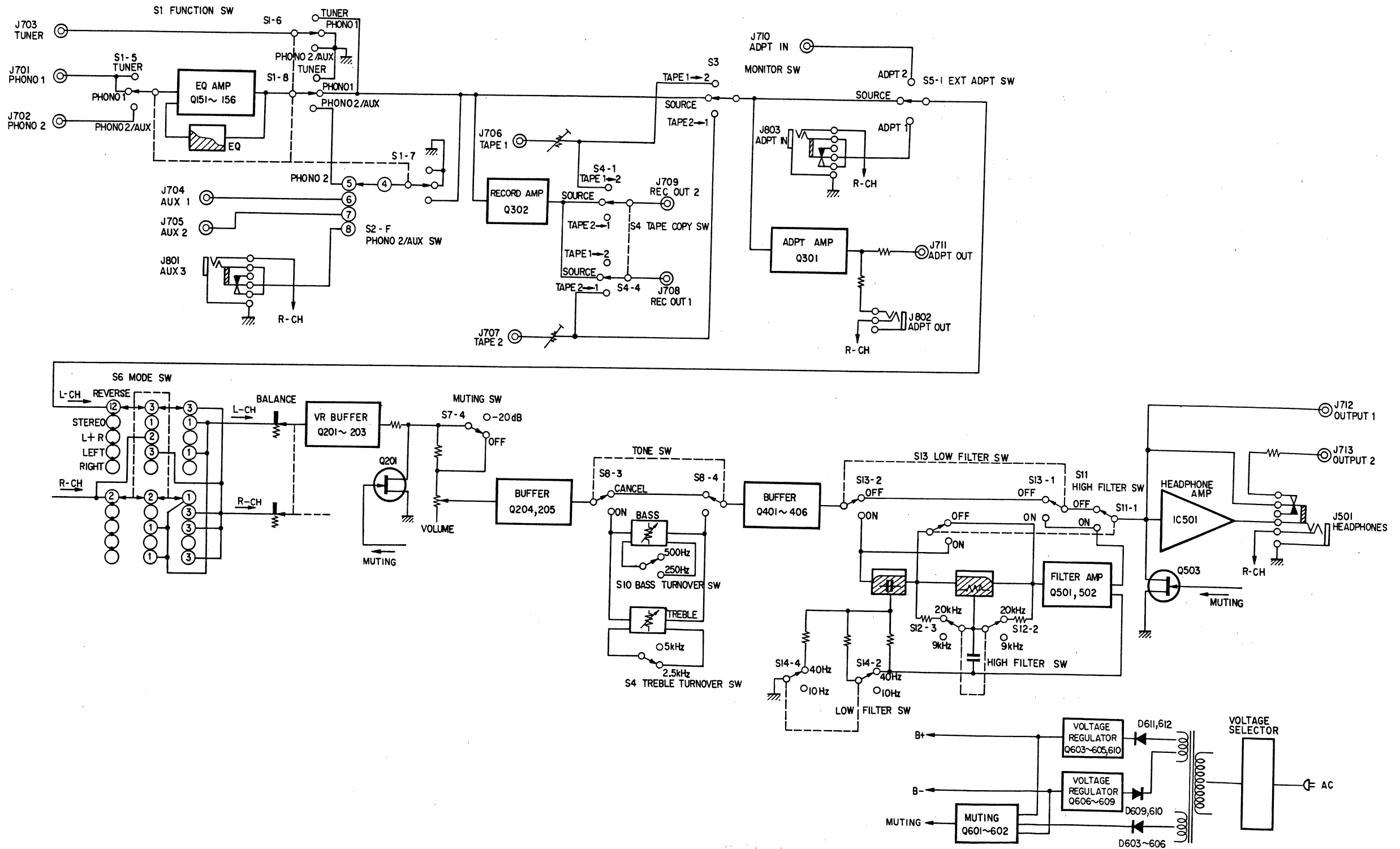

1-2. CIRCUIT BOARD REMOVAL

- 1. Remove four screws (B 4 x 22, black) from both wooden side panels, and remove the side panels and top cover.

- 2. Remove the respective screws from the front subchassis and remove board(s).

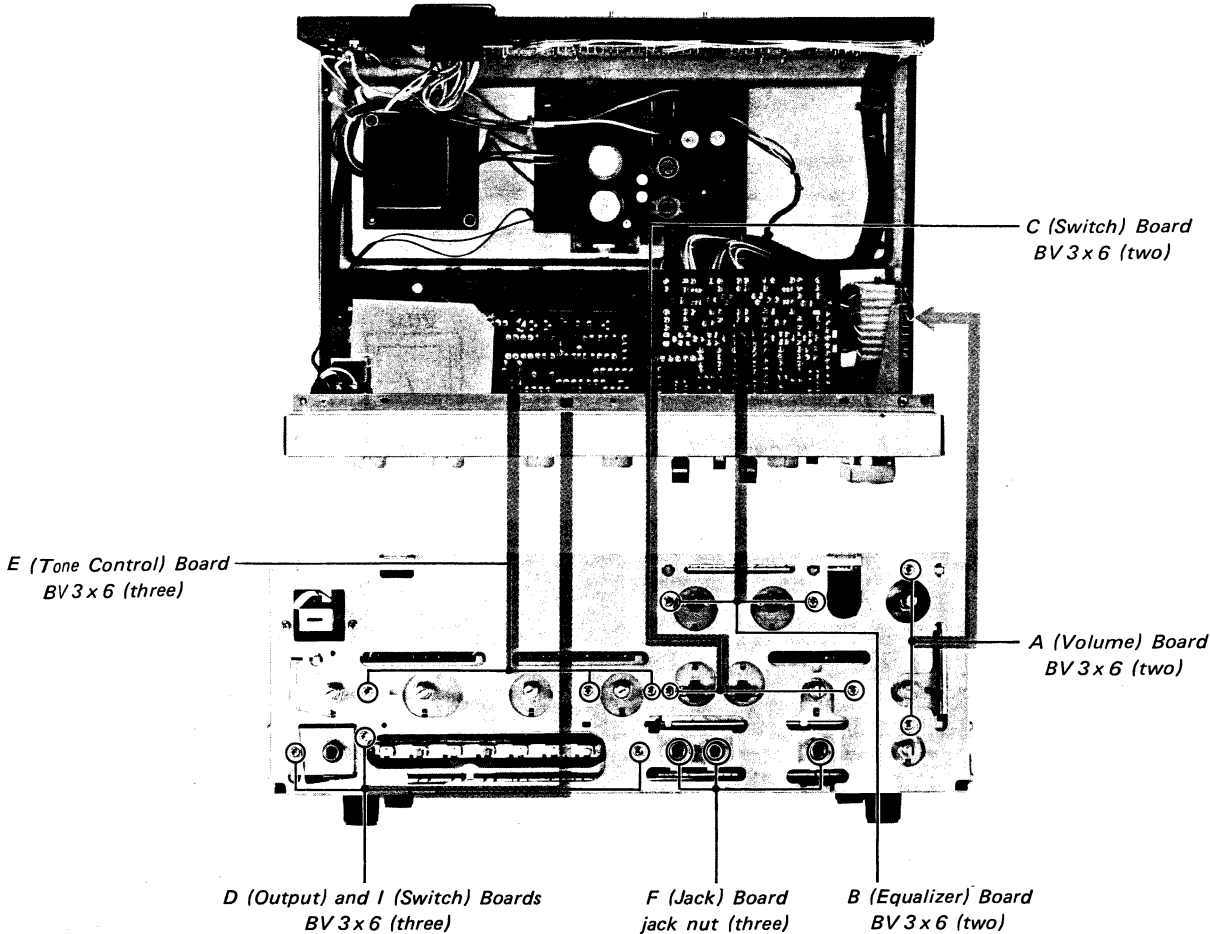

**SECTION 2
ADJUSTMENTS**

BALANCE ADJUSTMENT

Procedure:

With no input signal, adjust RV403 (L-CH) and RV453 (R-CH) so that the source voltage of Q405 (L-CH) and Q455 (R-CH) becomes 0 V.

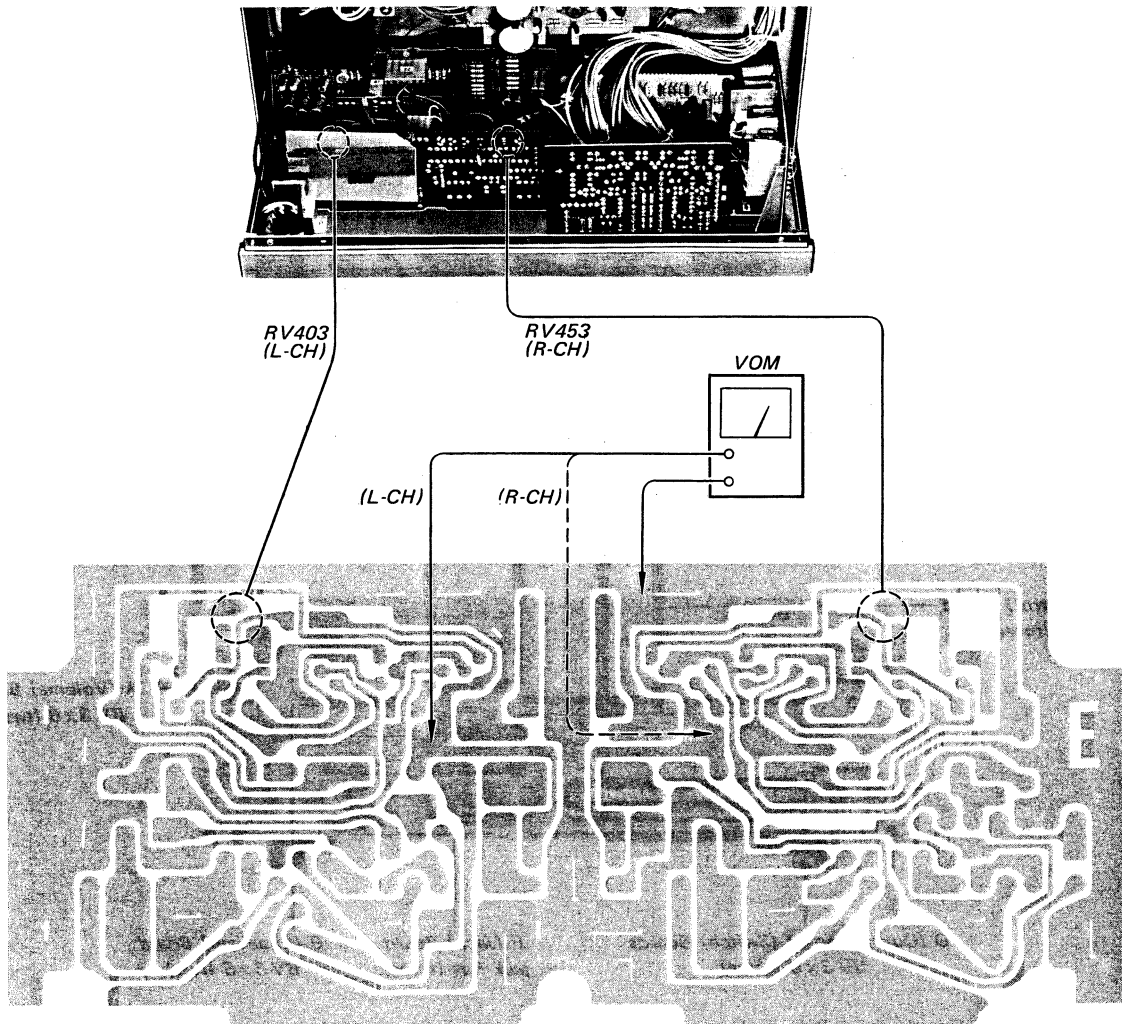

SECTION 3
DIAGRAMS

3-1. MOUNTING DIAGRAM - F (Jack) Board -

- Conductor Side -

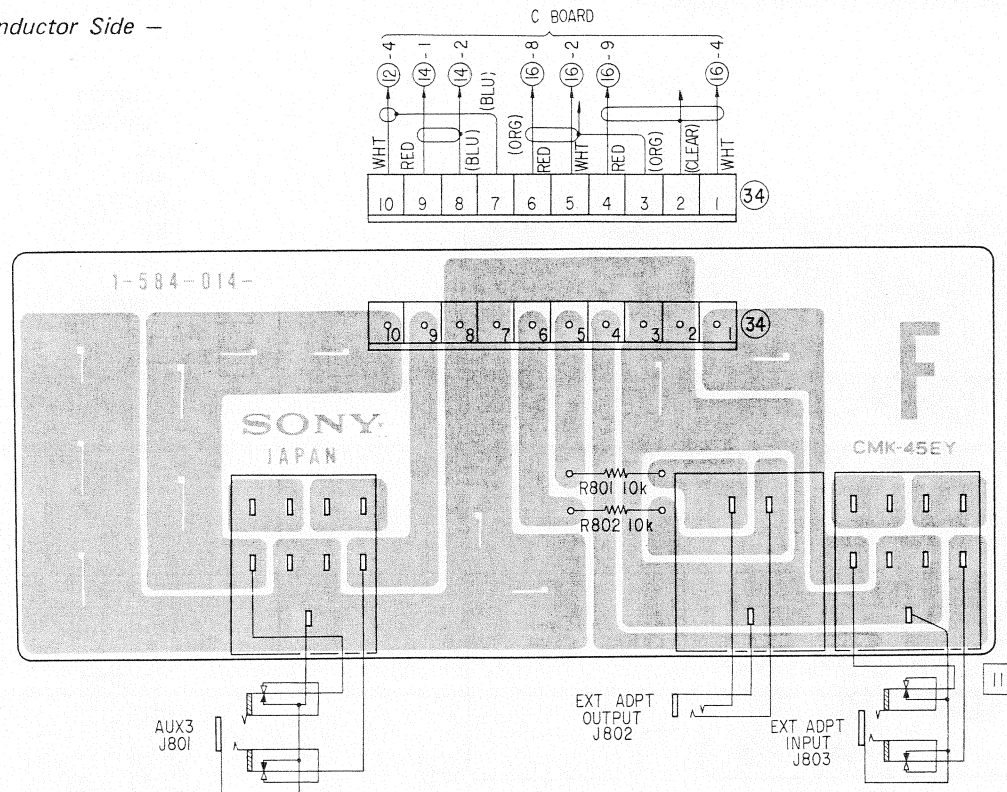

90°-bent Connector Base Post

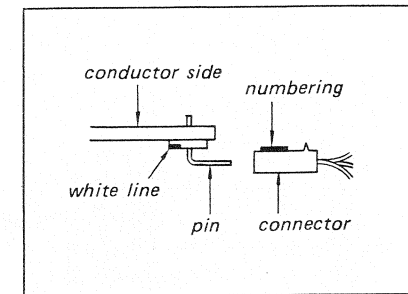

Note: All resistors are in Ω , $\frac{1}{4}$ W.

3-2. MOUNTING DIAGRAM - G (Jack) Board -

- Conductor Side -

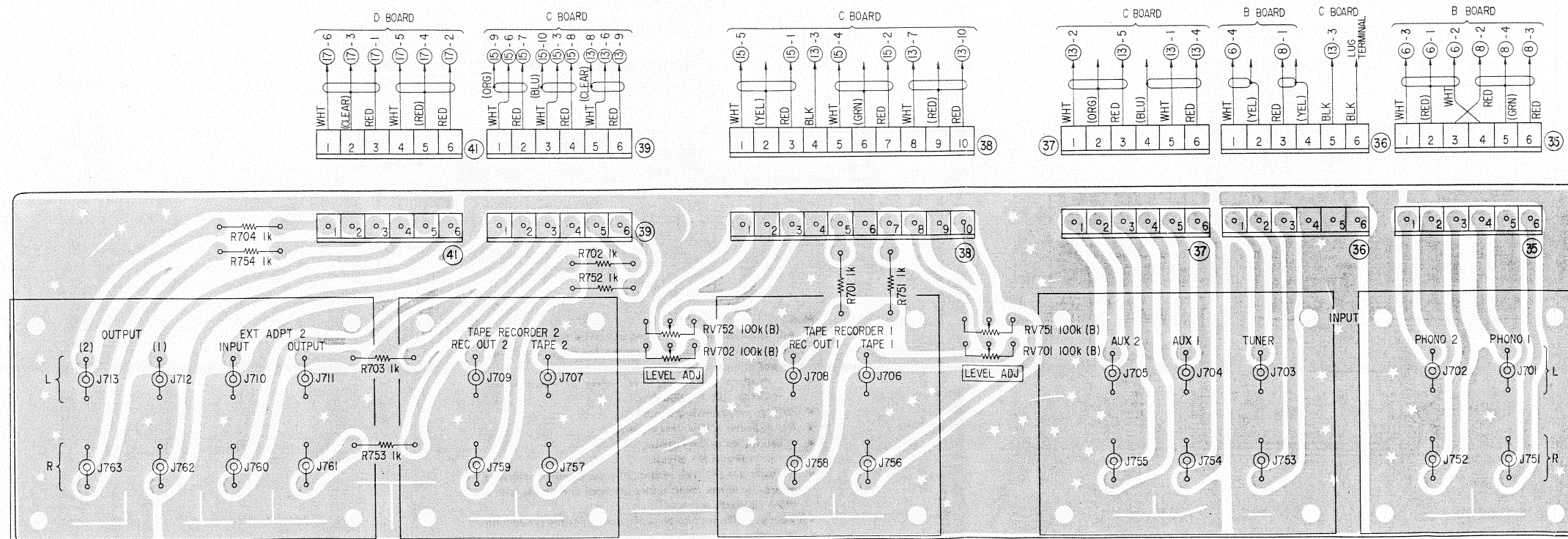

3-3. MOUNTING DIAGRAM – A (Volume) Board –

– Conductor Side –

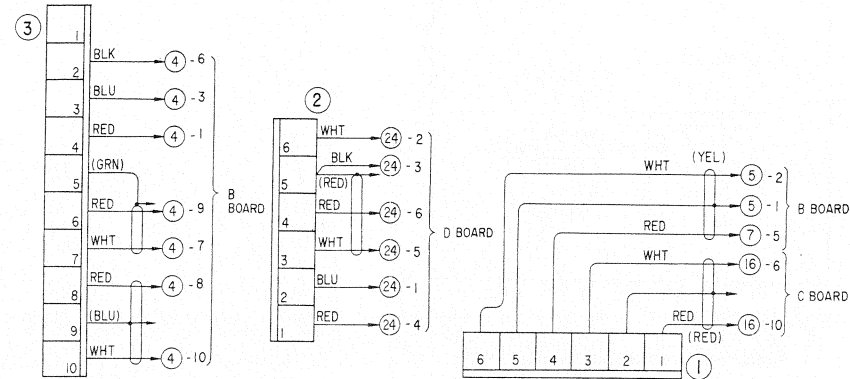

2SK43

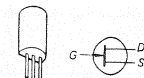

2SA705

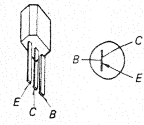

2SC632A

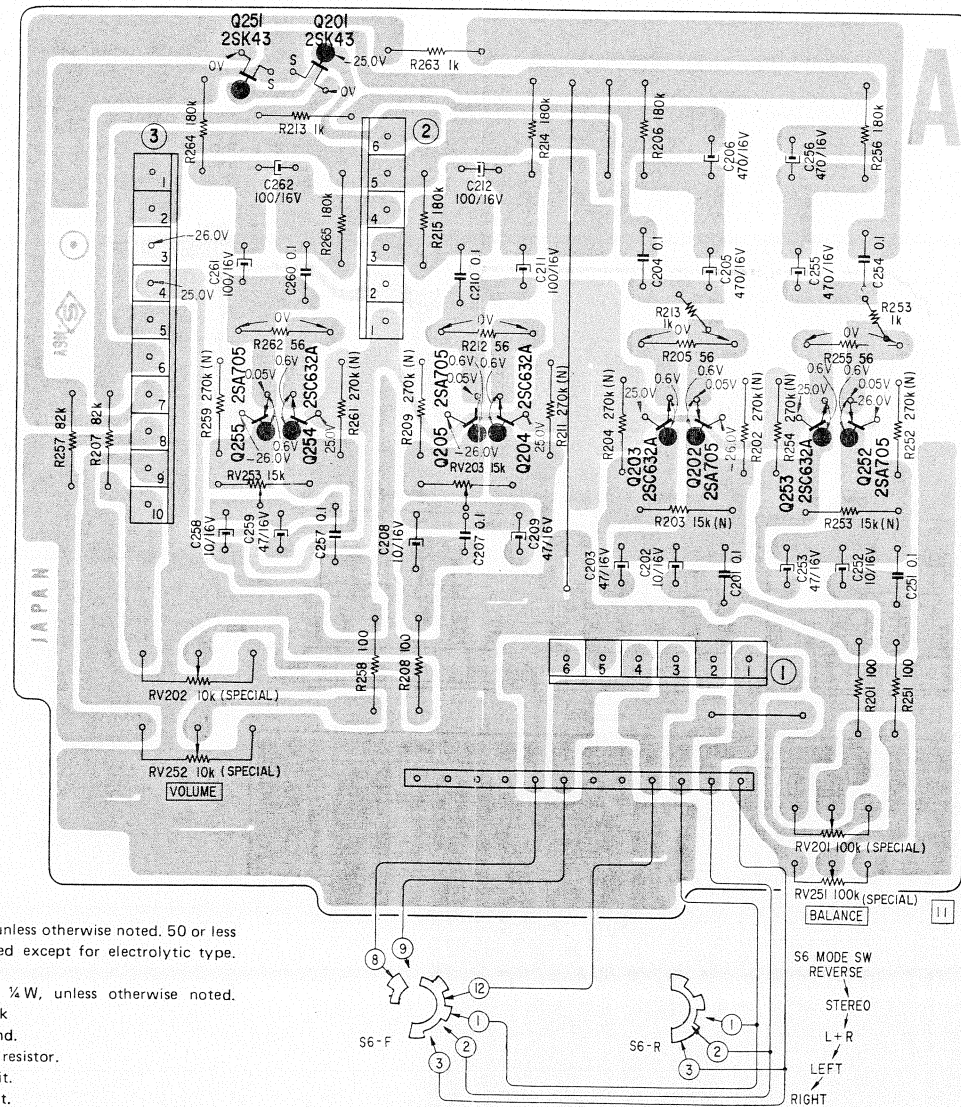
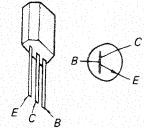

Note:

- All capacitors are in μF unless otherwise noted. 50 or less working volts are omitted except for electrolytic type. $p = \mu\mu\text{F}$
- All resistors are in Ω , $\frac{1}{4}W$, unless otherwise noted. $k = 1,000$ $M = 1,000 k$
- /// indicates chassis ground.
- (N) indicates a low-noise resistor.
- --- indicates B+ circuit.
- --- indicates B- circuit.
- Voltages are DC with respect to ground unless otherwise noted. Readings taken under no-signal conditions with a VOM (20k Ω/V).
- Voltage variations may be noted due to normal production tolerances.
- Voltage between base and emitter are measured with 2.5 V range.

3-4. MOUNTING DIAGRAM – H (Power Supply) Board –

– Conductor Side –

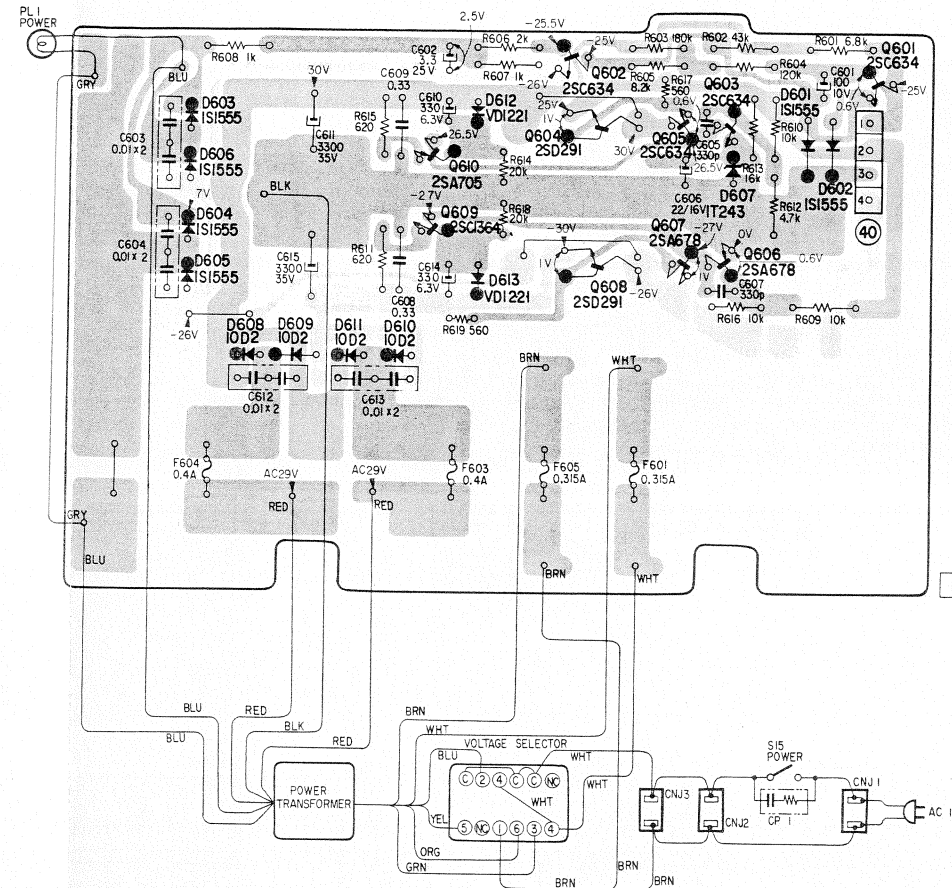

Q	D603	D606	D604	D605	D608	D609	D611	D610	Q610	D612	Q602	Q604	Q605	Q603	Q601
D	D605	D608	D609	D611	D610										

Note:

- All capacitors are in μF unless otherwise noted. 50 or less working volts are omitted except for electrolytic type. $p = \mu\mu\text{F}$
- All resistors are in Ω , $\frac{1}{4}W$, unless otherwise noted. $k = 1,000$ $M = 1,000 k$
- /// indicates chassis ground.
- (N) indicates a low-noise resistor.
- --- indicates B+ circuit.
- --- indicates B- circuit.
- Voltages are DC with respect to ground unless otherwise noted. Readings taken under no-signal conditions with a VOM (20k Ω/V).
- Voltage variations may be noted due to normal production tolerances.
- Voltage between base and emitter are measured with 2.5 V range.

2SA678
2SA705

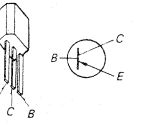

2SC634

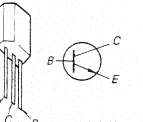

2SC1364

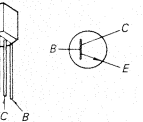

2SD291

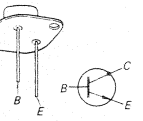

1S1555

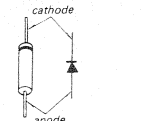

1T243

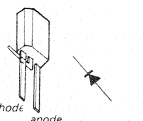

10D2

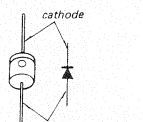

VD1221

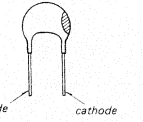

3-5. MOUNTING DIAGRAM — B (Equalizer) Board —

— Conductor Side —

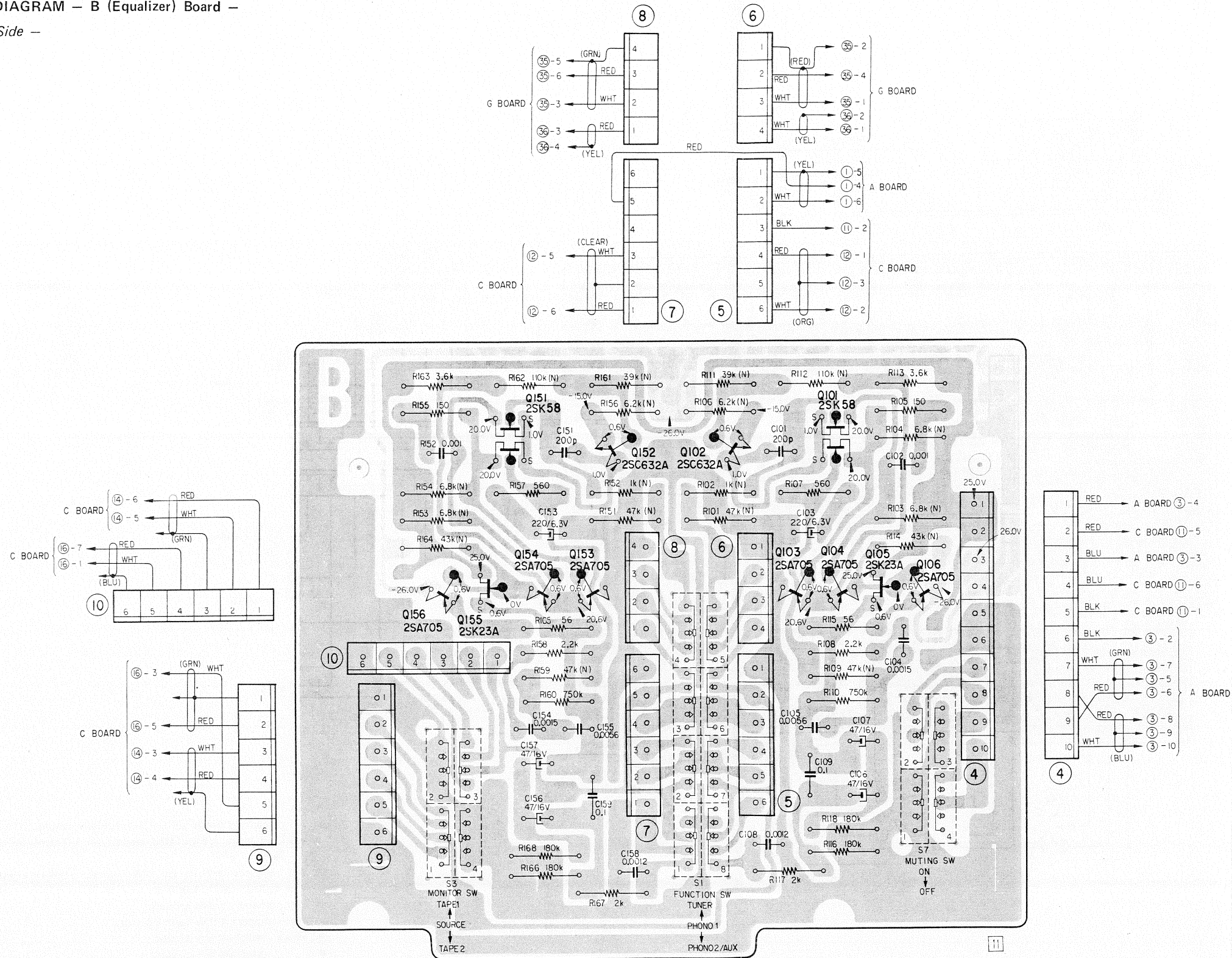

2SK58

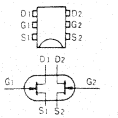

2SC632A

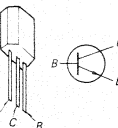

2SK23A

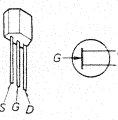

2SA705

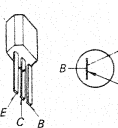

- Note:**
- All capacitors are in μF unless otherwise noted. 50 or less working volts are omitted except for electrolytic type. $p = \mu\text{F}$
 - All resistors are in Ω , $\frac{1}{2}W$, unless otherwise noted. $k = 1,000$ $M = 1,000 k$
 - --- indicates chassis ground.
 - (N) indicates a low-noise resistor.
 - --- indicates B+ circuit.
 - --- indicates B- circuit.
 - Voltages are DC with respect to ground unless otherwise noted. Readings taken under no-signal conditions with a VOM (20k Ω/V).
 - Voltage variations may be noted due to normal production tolerances.
 - Voltage between base and emitter are measured with 2.5 V range.

3-6. MOUNTING DIAGRAM - C (Switch) Board -
- Conductor Side -

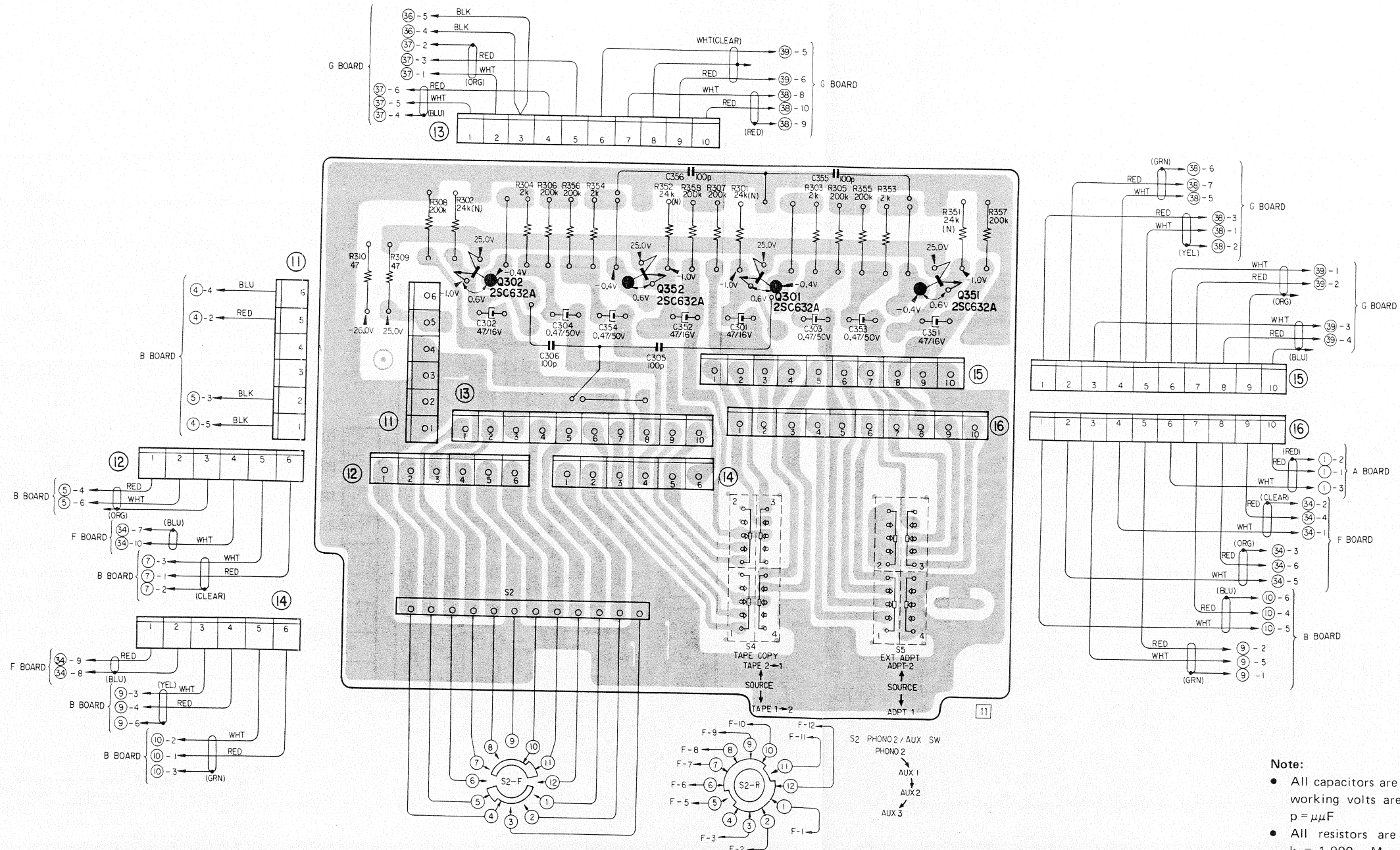

- Note:**
- All capacitors are in μF unless otherwise noted. 50 or less working volts are omitted except for electrolytic type. $\text{p} = \mu\mu\text{F}$
 - All resistors are in Ω , $\frac{1}{2}W$, unless otherwise noted. $\text{k} = 1,000$ $\text{M} = 1,000 \text{ k}$
 - /// indicates chassis ground.
 - (N) indicates a low-noise resistor.
 - B+ indicates B + circuit.
 - B- indicates B - circuit.
 - Voltages are DC with respect to ground unless otherwise noted. Readings taken under no-signal conditions with a VOM (20 $\text{k}\Omega/V$).
 - Voltage variations may be noted due to normal production tolerances.
 - Voltage between base and emitter are measured with 2.5 V range.

3-7. MOUNTING DIAGRAM - D (Output) Board -
- Conductor Side -

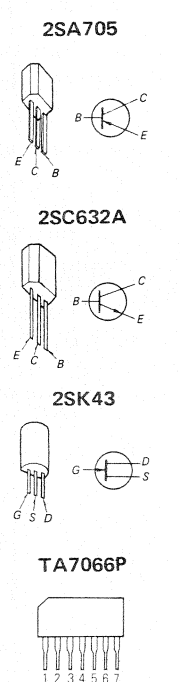
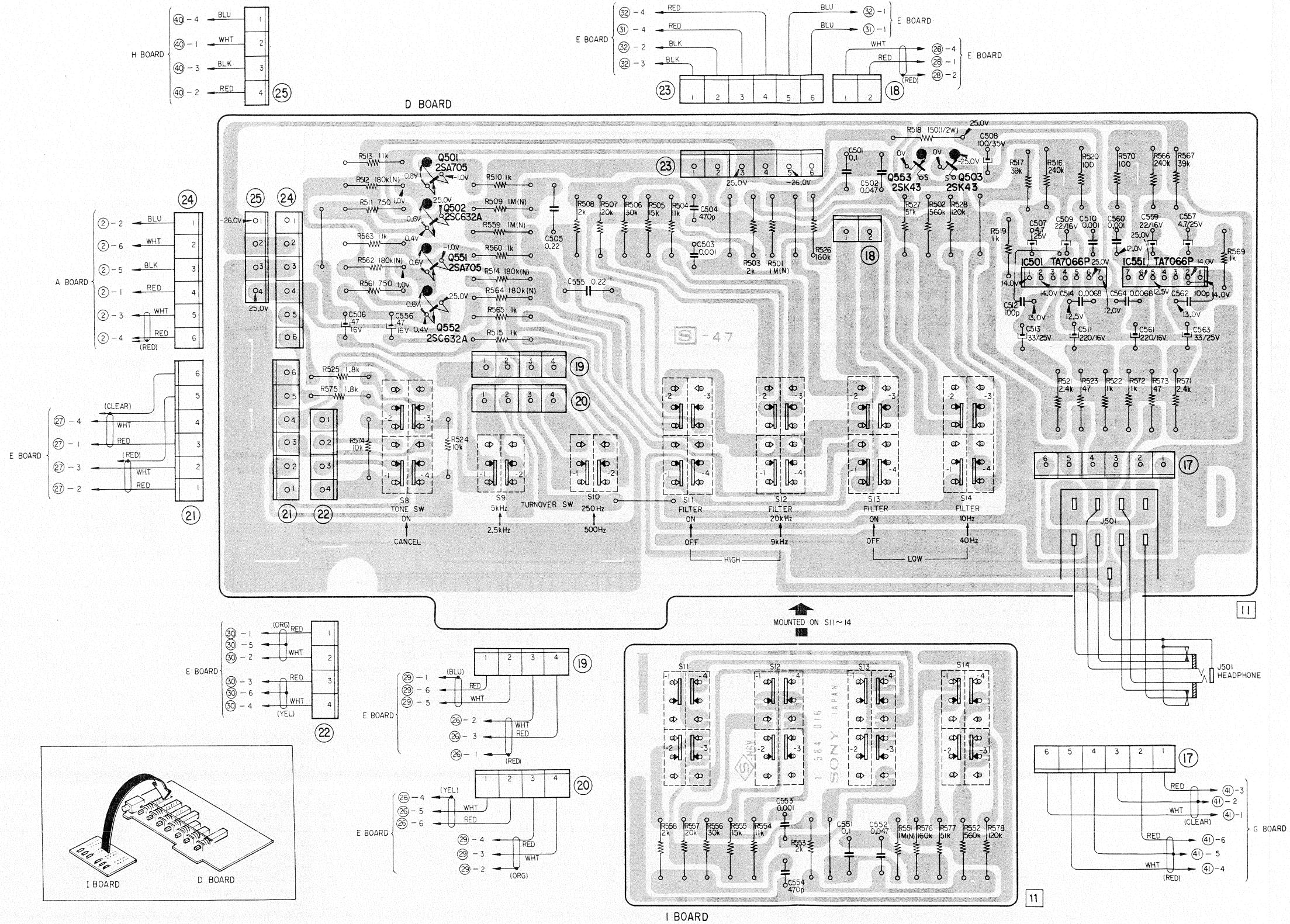

Note:

- All capacitors are in μF unless otherwise noted. 50 or less working volts are omitted except for electrolytic type. $\text{p} = \mu\text{F}$
- All resistors are in Ω , $\frac{1}{4}\text{W}$, unless otherwise noted. $\text{k} = 1,000$ $\text{M} = 1,000\text{k}$
- /// indicates chassis ground.
- (N) indicates a noise resistor.
- /// indicates B+ circuit.
- /// indicates B- circuit.
- Voltages are DC with respect to ground unless otherwise noted. Readings taken under no-signal conditions with a VOM (20 $\text{k}\Omega/\text{V}$).
- Voltage variations may be noted due to normal production tolerances.
- Voltage between base and emitter are measured with 2.5 V range.

TAE-5450 TAE-5450

3-8. MOUNTING DIAGRAM — E (Tone Control) Board —

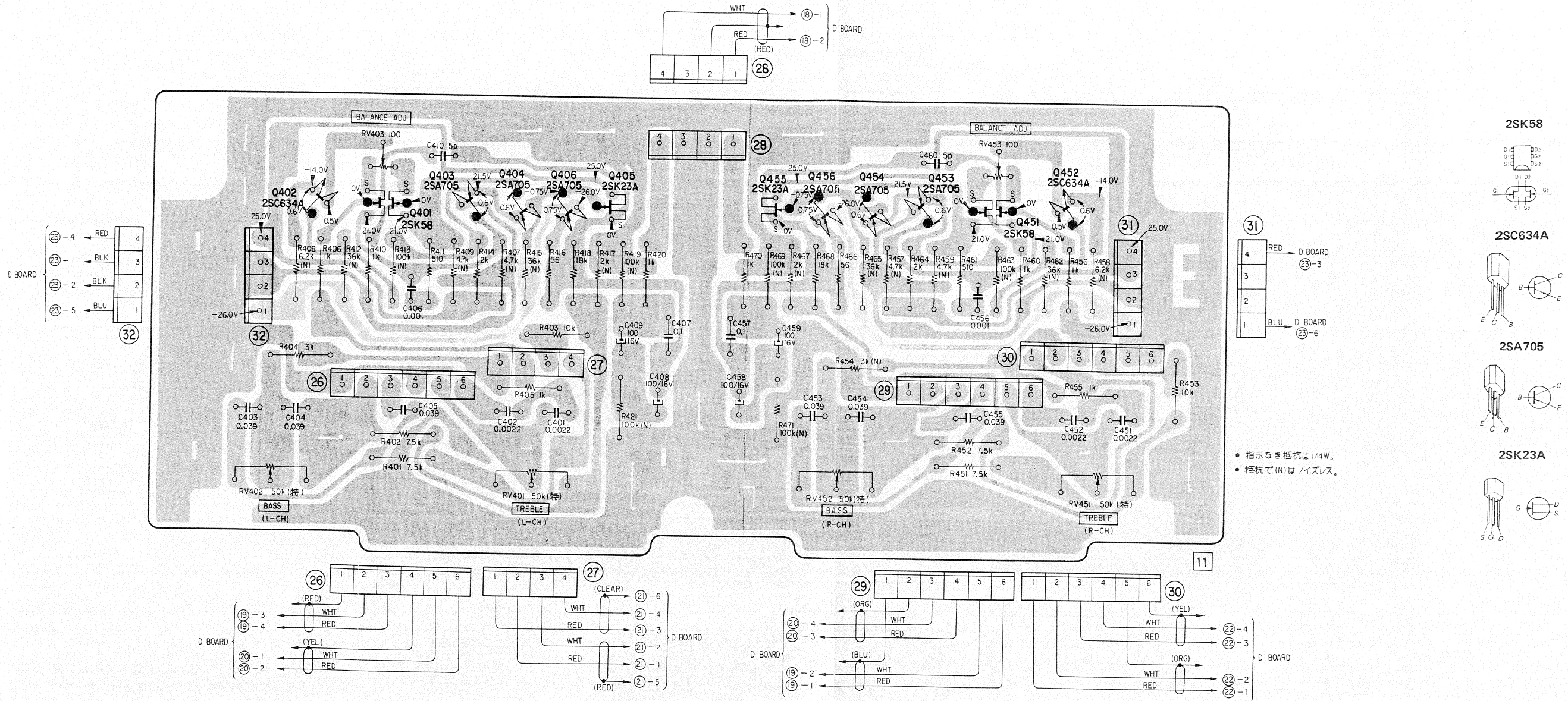

● 指示なき抵抗は 1/4W.
● 抵抗で (N) は ノイズレス。

- Note:**
- All capacitors are in μF unless otherwise noted. 50 or less working volts are omitted except for electrolytic type. $p = \mu\text{F}$
 - All resistors are in Ω , $\frac{1}{4}W$, unless otherwise noted. $k = 1,000$ $M = 1,000k$
 - --- indicates chassis ground.
 - (N) indicates a low-noise resistor.
 - --- indicates B+ circuit.
 - --- indicates B- circuit.
 - Voltages are DC with respect to ground unless otherwise noted. Readings taken under no-signal conditions with a VOM (20 $k\Omega/V$).
 - Voltage variations may be noted due to normal production tolerances.
 - Voltage between base and emitter are measured with 2.5 V range.

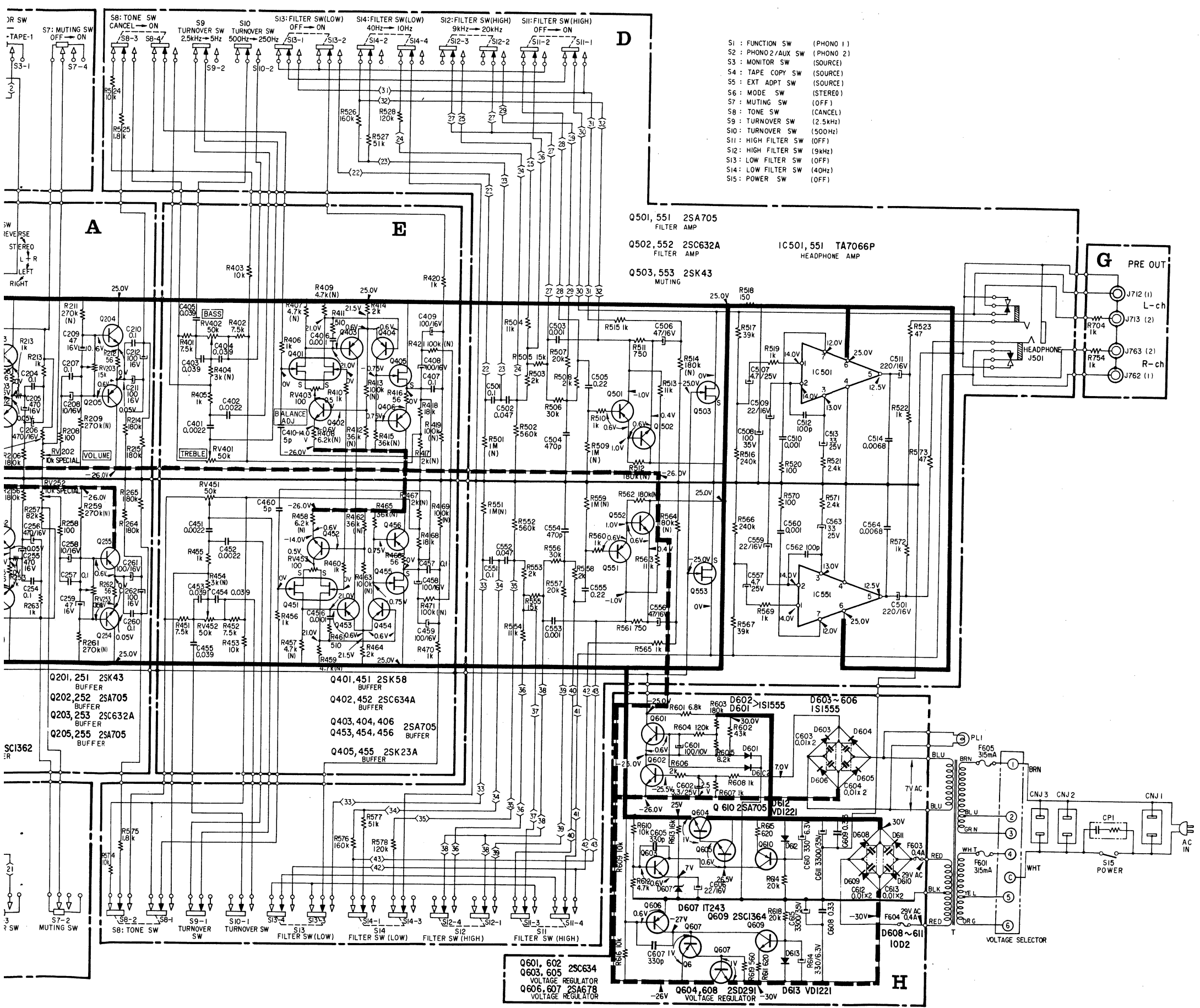

- S1 : FUNCTION SW (PHONO 1)
- S2 : PHONO 2/AUX SW (PHONO 2)
- S3 : MONITOR SW (SOURCE)
- S4 : TAPE COPY SW (SOURCE)
- S5 : EXT ADPT SW (SOURCE)
- S6 : MODE SW (STEREO)
- S7 : MUTING SW (OFF)
- S8 : TONE SW (CANCEL)
- S9 : TURNOVER SW (2.5kHz)
- S10 : TURNOVER SW (500Hz)
- S11 : HIGH FILTER SW (OFF)
- S12 : HIGH FILTER SW (9kHz)
- S13 : LOW FILTER SW (OFF)
- S14 : LOW FILTER SW (40Hz)
- S15 : POWER SW (OFF)

Q501, 551 2SA705
FILTER AMP

Q502, 552 2SC632A
FILTER AMP

IC501, 551 TA7066P
HEADPHONE AMP

Q503, 553 2SK43
MUTING

- Note:**
- All capacitors are in μF unless otherwise noted. 50 or less working volts are omitted except for electrolytic type. $p = \mu\text{F}$
 - All resistors are in Ω , $\frac{1}{4}W$, unless otherwise noted. $k = 1,000$ $M = 1,000k$
 - --- indicates chassis ground.
 - (N) indicates a low-noise resistor.
 - --- indicates B+ circuit.
 - --- indicates B- circuit.
 - Voltages are DC with respect to ground unless otherwise noted. Readings taken under no-signal conditions with a VOM (20 $k\Omega/V$).
 - Voltage variations may be noted due to normal production tolerances.
 - Voltage between base and emitter are measured with 2.5 V range.

SECTION 4
EXPLODED VIEWS

4-1. EXPLODED VIEW (1)

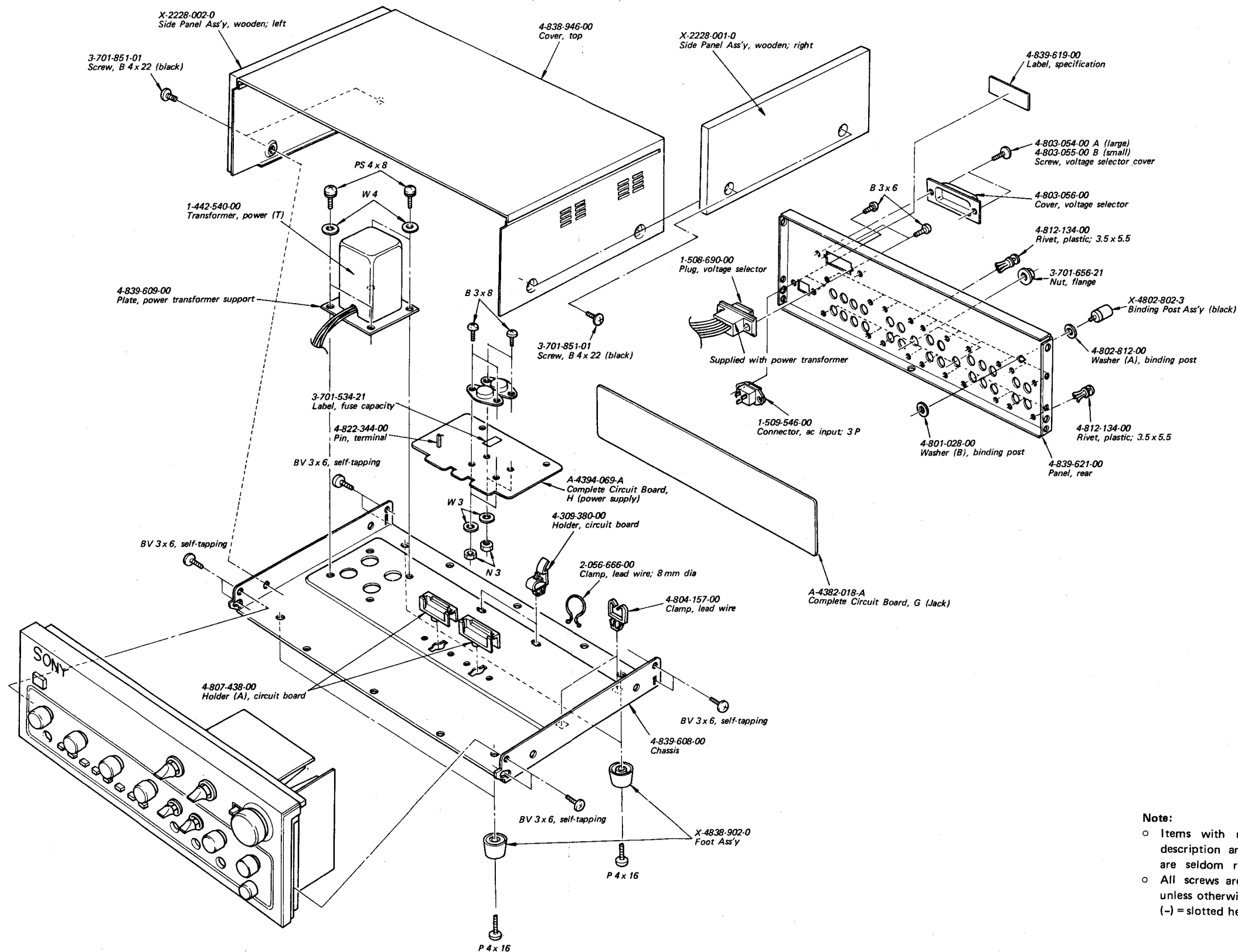

Note:

- Items with no part number and/or no description are not stocked because they are seldom required for routine service.
- All screws are Phillips (cross recess) type unless otherwise noted.
- (-) = slotted head

Ref. No. Part No. Description

FUSES

F601,605 1-532-235-00 315 mA
 F603,604 1-532-066-00 0.4 A

JACKS

J501 1-507-453-00 Binaural; HEADPHONE

J701,702 }
 J706~709 } 1-507-416-00 Phono, 4 p
 J751,752 }
 J756~759 }

J703~705 }
 J753~755 } 1-507-386-00 Phono, 6 p
 J710~713 }
 J760~763 } 1-507-387-00 Phono, 8 p

J801,803 1-507-453-00 AUX 3/EXT ADPT-INPUT
 J802 1-507-454-00 EXT ADPT-OUTPUT

Ref. No. Part No. Description

MISCELLANEOUS

CP1 1-101-534-00 Encapsulated Component
 PL 1-518-158-00 Lamp, POWER 8 V 30 mA
 T 1-442-540-00 Transformer, power
 1-508-690-00 Plug, voltage selector
 1-509-546-00 Connector, ac input; 3 p

CONNECTOR PINS

1-508-692-31 6 p
 1-508-692-41 10 p
 1-508-746-00 2 p
 1-508-747-00 4 p
 1-508-748-00 6 p
 1-508-750-00 10 p

Part No. Description

ACCESSORIES

1-506-113-00 Plug, shorting
 1-534-049-51 Cord, connection; RK-74H
 1-534-514-13 Cord, connection; RK-81H
 1-534-514-22 Cord, connection; RK-81H
 3-780-567-21 Manual, instruction

**SECTION 6
HARDWARE****HARDWARE**

Part No. Description

Screws

All screws are Phillips (cross recess)
type unless otherwise noted.

7-682-165-01	P 4 × 16
7-682-547-05	B 3 × 6
7-682-548-01	B 3 × 8
7-682-661-01	PS 4 × 8
7-685-802-01	BV 3 × 6, self-tapping
7-685-546-05	BV 3 × 8, self-tapping

Washers

7-623-108-11	3
7-623-110-12	4

Sony Corporation

© 1975
— 32 —

9-958-091-01

5H0628.1
Printed in Japan